

Article number: 20193B50V50762BL
 Description: E+G T-angle clamp
 GN 193-B50-V50-76-2-BL

Measures

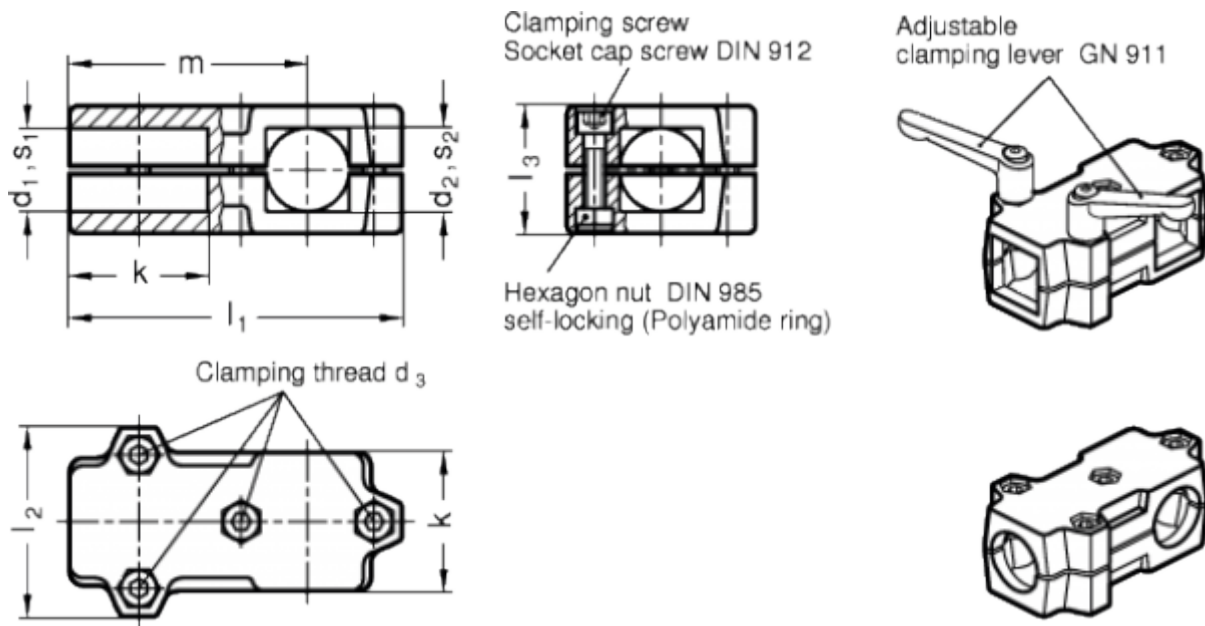

Accessories = GN 911-M10-63	m	= -
d1 = 50	s1	= -
d2 = -	s2	= 50
d3 = M10	Weight in (g)	= 1086
k = 76		
l1 = 176		
l2 = 98		
l3 = 70		